

PC板间隔柱 SPACER SUPPORT

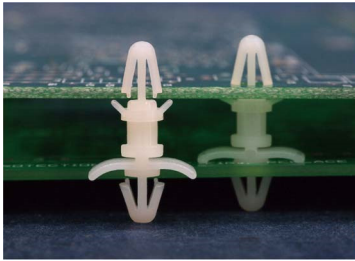

MATERIAL : NYLON 66(UL)
 FLAME CLASS : 94V-0,94V-2
 COLOR : BLACK,NATURAL
 UNIT: mm

用途 : PC板与PC板间之固定, 不占空间

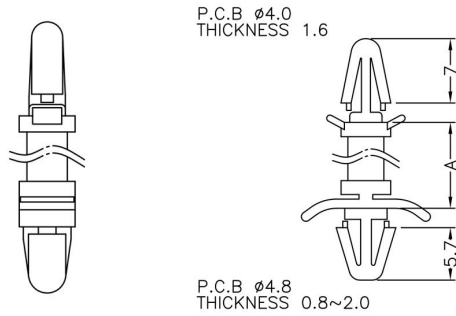

PART NO	A	PACKAGE
PCSS-253	5.0	1000
PCSS-254	6.3	1000
PCSS-255	8.0	1000
PCSS-256	10.0	1000
PCSS-257	12.7	1000
PCSS-258	15.9	1000
PCSS-259	20.0	1000
PCSS-260	25.0	1000

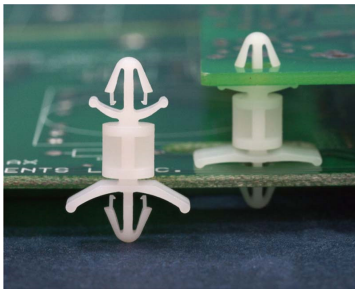

MATERIAL : NYLON 66(UL)
 FLAME CLASS : 94V-0,94V-2
 COLOR : BLACK,NATURAL
 UNIT: mm

用途 : PC板与PC板间之固定, 不占空间

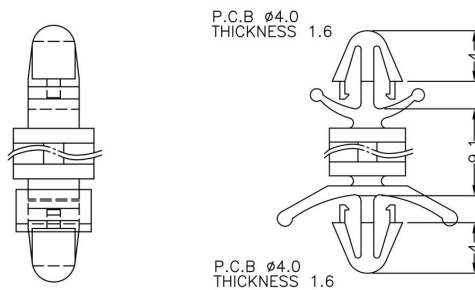

PART NO	PACKAGE
PCSS-261	1000

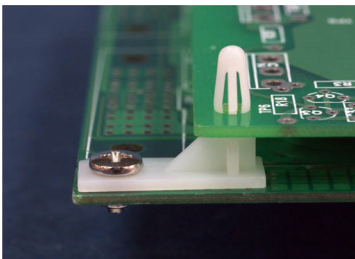

MATERIAL : NYLON 66(UL)
 FLAME CLASS : 94V-0,94V-2
 COLOR : BLACK,NATURAL
 UNIT: mm

用途 : 机板部分用螺丝固定, 另一头直接压入PC板。

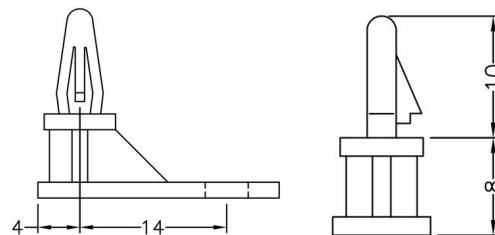
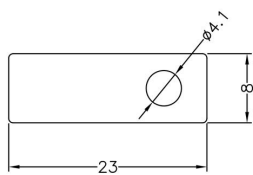

PART NO	PACKAGE
PCSS-262	1000

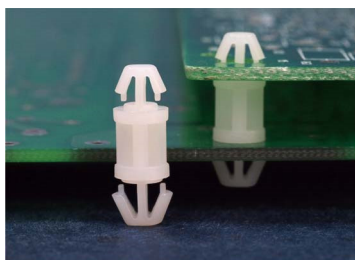

MATERIAL : NYLON 66(UL)
 FLAME CLASS : 94V-0,94V-2
 COLOR : BLACK,NATURAL
 UNIT: mm

用途 : PC板与PC板间之固定, 不占空间

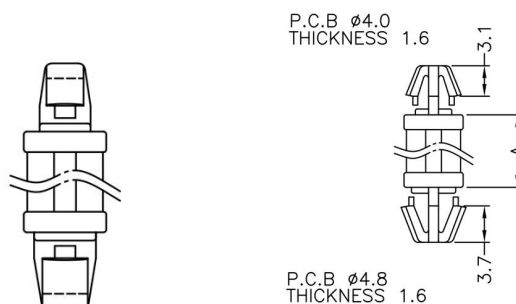

PART NO	A	PACKAGE
PCSS-263	3.0	1000
PCSS-264	4.0	1000
PCSS-265	6.0	1000
PCSS-266	8.0	1000
PCSS-270	16.0	1000
PCSS-267	10.0	1000
PCSS-268	12.0	1000
PCSS-269	14.0	1000
PCSS-271	18.0	1000